

Power Amplifier with T/R Switch for 802.11b

Preliminary Release

V 1.3

AM52-0023

Features

- WLAN and Bluetooth Applications
- Meets 802.11b Spectral Mask Requirements at +20 dBm PA Output Power
- Integrated SPDT Switch
- Integrated Detector
- Downset Leadframe for Excellent Heat Dissipation
- High Power, Low Power, Shutdown Modes

Description

The AM52-0023 is a two stage power amplifier designed for 802.11b and other 2.4 GHz applications. This product includes a detector and a T/R switch. Transmit specifications are given at the antenna port and include the switch insertion loss. The small size and height of the AM52-0023 make it ideal for PC card applications.

The AM52-0023 has three operating modes; High Power, Low Power, and Shutdown. The High Power Mode has both the first and second PA stages biased on and is achieved by setting both Vctrl1 and Vctrl2 to +3 volts. The Low Power Mode has the first PA stage on and the second PA stage off and is achieved by setting Vctrl1 to +3 volts and Vctrl2 to 0 volts. The Shutdown Mode is achieved by setting both Vctrl1 and Vctrl2 to 0 volts.

Handling Procedures

Please observe the following precautions to avoid damage to the AM52-0023:

Static Sensitivity

Gallium arsenide integrated circuits are ESD sensitive and can be damaged by static electricity. Use proper ESD precautions when handling these devices.

Ordering Information

Part Number	Description
AM52-0023TR	7 inch, 1000 piece reel
AM52-0023TR-3000	13 inch, 3000 piece reel
AM52-0023SMB	AM52-0023 Sample Test Board

Functional Schematic

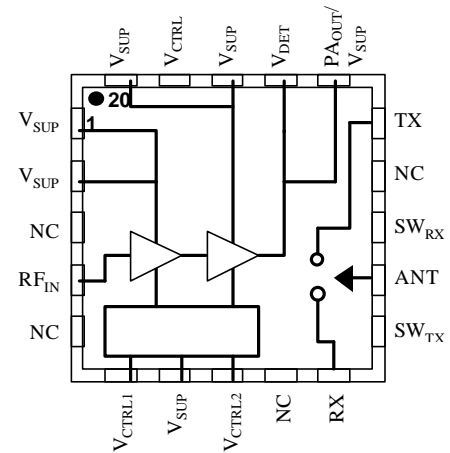

Pin Configuration

Pin No.	Function	Description
3, 5, 9, 14	NC	No Connection
4	RF _{IN}	RF Input to Amplifier
1, 2, 7, 18, 20	V _{SUPPLY}	DC Supply
6	V _{CTRL1}	Power Control, Stage 1
8	V _{CTRL2}	Power Control, Stage 2
10	RX	Receive Port on Switch
11	SW _{TX}	Switch Control
12	ANT	Switch Antenna Port
13	SW _{RX}	Switch Control
15	TX	Switch Transmit Port
16	PA _{OUT} /V _{SUP}	PA Output, DC Supply
17	V _{DET}	Detected Output Power
19	V _{CTL}	Detector Control
Base	GND	RF/DC Ground

Specifications subject to change without notice.

- North America: Tel. (800) 366-2266
- Asia/Pacific: Tel.+81-44-844-8296, Fax +81-44-844-8298
- Europe: Tel. +44 (1344) 869 595, Fax+44 (1344) 300 020

Visit www.macom.com for additional data sheets and product information.

tyco Electronics

MACOM

Absolute Maximum Ratings¹

Parameter	Maximum
Max Input Power (2.4 -2.5 GHz)	+ 10 dBm
Operating Voltages	+5.5 volts
Operating Temperature	-40 °C to +85 °C
Channel Temperature	+150 °C
Storage Temperature	-40 °C to +150 °C

1. Exceeding any one or combination of these limits may cause permanent damage.

Electrical Specifications^{1,2}: T_C=+38°C

Parameter	Test Conditions	Units	Min.	Typ.	Max.
Frequency		GHz	2.4		2.5
Control voltage range		V	0.0		3.0
Input Return Loss at RFin	Pin=0 dBm, V _{CTRL1} =3.0V, V _{CTRL2} =3.0V	dB	14	24	
	Pin=0 dBm, V _{CTRL1} =3.0V, V _{CTRL2} =0.0V	dB	14	20	
Output Power at ANT	Pin=0 dBm, V _{CTRL1} =3.0V, V _{CTRL2} =3.0V	dBm		20	
	Pin=0 dBm, V _{CTRL1} =3.0V, V _{CTRL2} =0.0V	dBm		0	
1 dB Compression at ANT	V _{CTRL1} =3.0V, V _{CTRL2} =3.0V	dBm		23	
Saturated Power at ANT	V _{CTRL1} =3.0V, V _{CTRL2} =3.0V	dBm		24	
Power Gain at ANT	Pin=0 dBm, V _{CTRL1} =3.0V, V _{CTRL2} =3.0V	dB	18	20	
	Pin=0 dBm, V _{CTRL1} =3.0V, V _{CTRL2} =0.0V	dB	-2	0	
Current, Operating	Pin=0 dBm, V _{CTRL1} =3.0V, V _{CTRL2} =3.0V (High Power Mode)	mA		250	300
	Pin=0 dBm, V _{CTRL1} =3.0V, V _{CTRL2} =0.0V (Low Power Mode)	mA		22	30
	Pin=0 dBm, V _{CTRL1} =0.0V, V _{CTRL2} =0.0V (Shutdown Mode)	uA		10	
Control current	Pin=0 dBm, V _{CTRL1} =3.0V, V _{CTRL2} =3.0V	mA		5	
	Pin=0 dBm, V _{CTRL1} =3.0V, V _{CTRL2} =0.0V	mA		0.2	
Isolation, Forward (RF _{IN} to ANT)	V _{CTRL1} =3.0V, V _{CTRL2} =0.0V, V _{TX} =0.0V, V _{RX} =3.0V	dB		45	
Isolation, ANT to RX	V _{TX} =3.0V, V _{RX} =0.0V	dB	18	20	
Insertion loss, ANT to RX	V _{TX} =0.0V, V _{RX} =3.0V	dB		0.7	0.9
Harmonics, all	P _{IN} =0 dBm, P _{OUT} =23 dBm, V _{CTRL1} =3.0V, V _{CTRL2} =3.0V	dBc		-40	
Detector Output	Pin=0 dBm, V _{CTRL1} =3.0V, V _{CTRL2} =3.0V	V	1.4	1.6	
Duty cycle		%			100
Output Power for Linear Operation	At ANT, Compliance with 802.11b DSSS	dBm		20	
Stability	+3.0V<V _{CC} <+3.6V, P _{OUT} <20dBm, VSWR<6:1, -25°C<T _C <+85°C, RBW=3MHz max hold		All spurs <-70dBc		
Ruggedness	+3.0V<V _{CC} <+5.5V, P _{OUT} <23dBm, VSWR<10:1		No permanent damage		

1. Test frequency is 2450 MHz unless otherwise specified.
2. Supply voltage is +3.0 volts unless otherwise specified.

Switch Logic Table^{1,2,3}

Insertion Loss Path	Isolated Path	SW _{RX}	SW _{TX}
RX/ANT	TX/ANT	1	0
TX/ANT	RX/ANT	0	1

1. "0" = 0 +/- 0.2 volts
2. "1" = +2.7 to +5 volts
3. DC Blocking capacitors required on all T/R switch RF ports (pins 10, 12, and 15)

Specifications subject to change without notice.

- North America: Tel. (800) 366-2266
- Asia/Pacific: Tel.+81-44-844-8296, Fax +81-44-844-8298
- Europe: Tel. +44 (1344) 869 595, Fax+44 (1344) 300 020

Typical Performance Curves

Output Power, High Power Mode

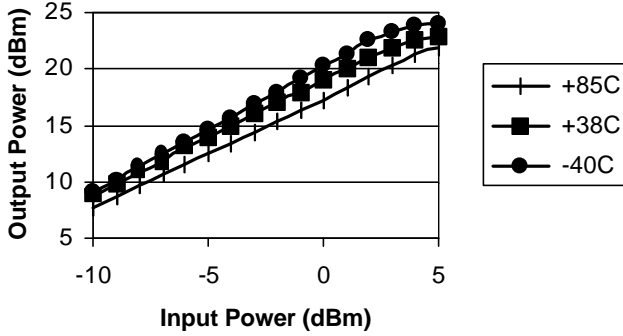

Detector Output, High Power Mode

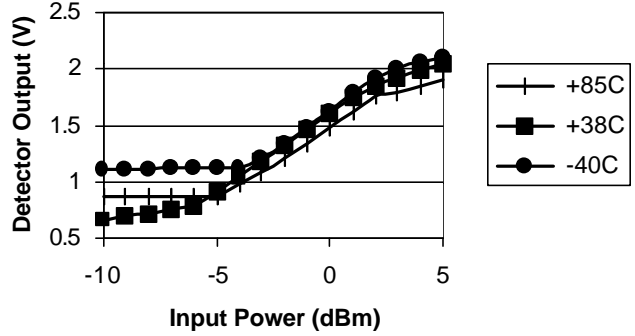

Detector Output, High Power Mode

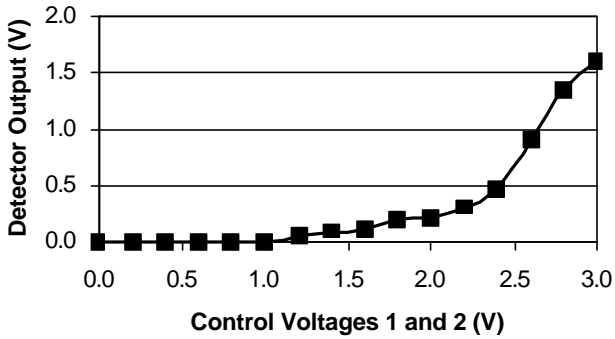

Detector Output, Low Power Mode

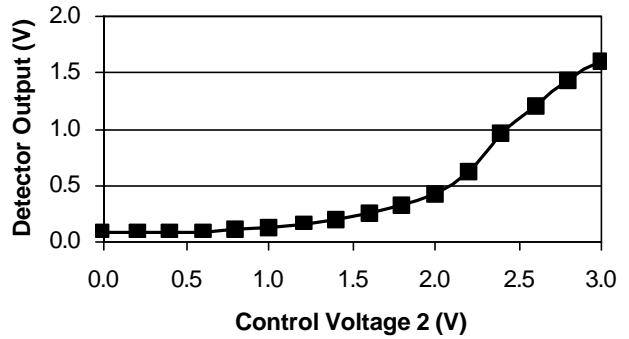

Supply Current, High Power Mode

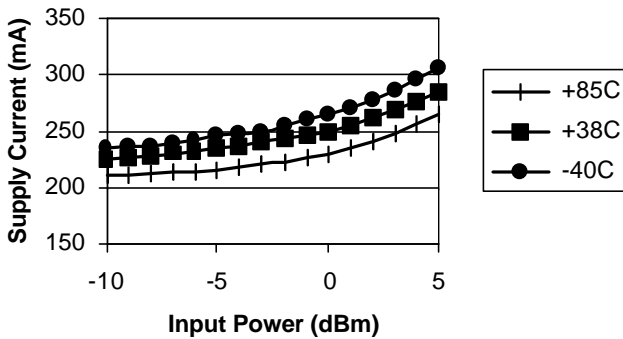

Supply Current, Low Power Mode

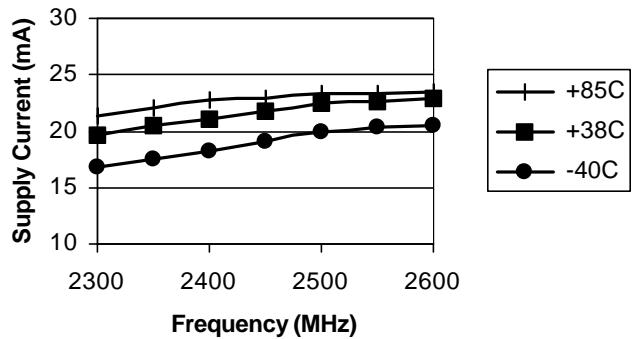

Specifications subject to change without notice.

- North America: Tel. (800) 366-2266
- Asia/Pacific: Tel.+81-44-844-8296, Fax +81-44-844-8298
- Europe: Tel. +44 (1344) 869 595, Fax+44 (1344) 300 020

Gain, High Power Mode

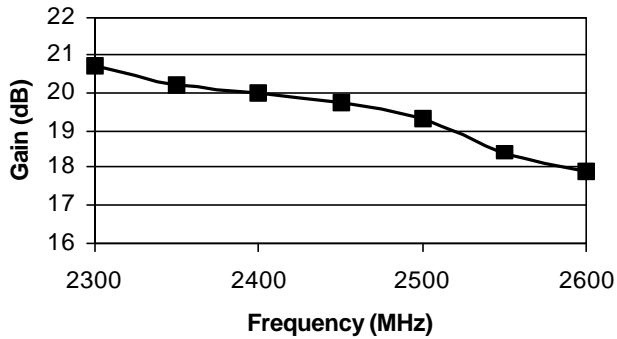

Gain, Low Power Mode

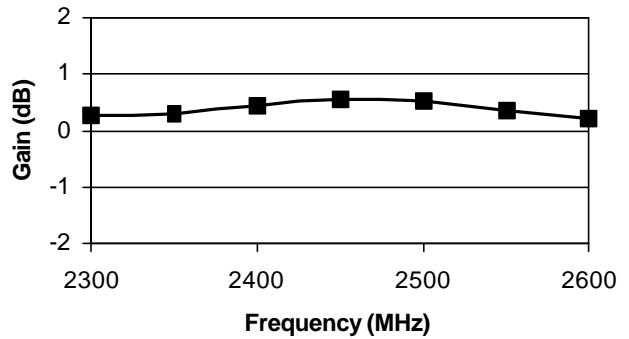

Input Return Loss, High Power Mode

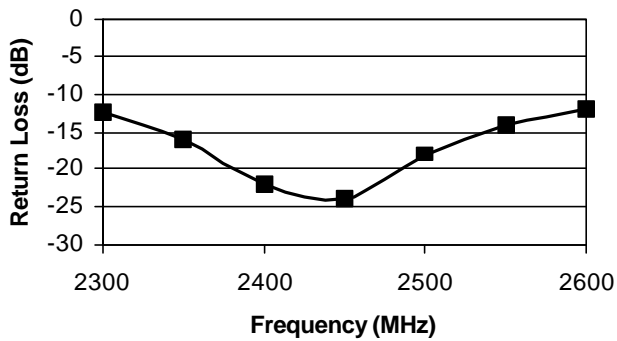

Input Return Loss, Low Power Mode

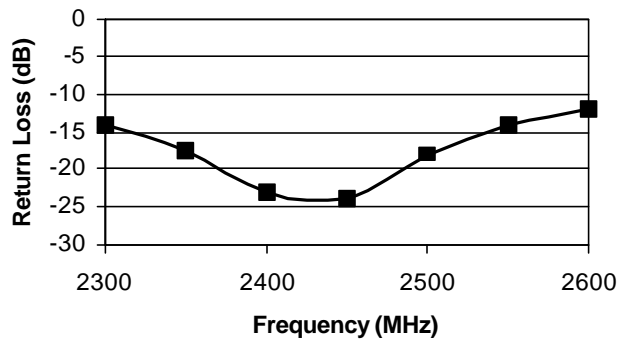

Switch Insertion Loss

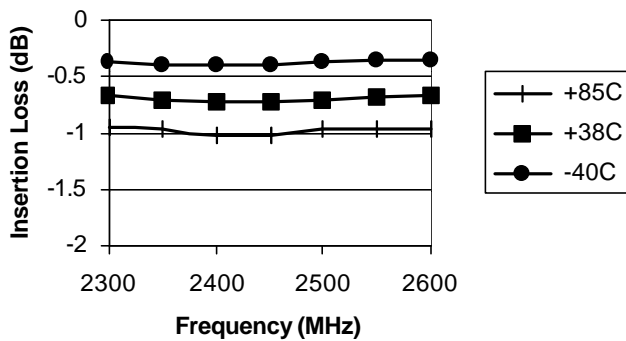

Switch Isolation

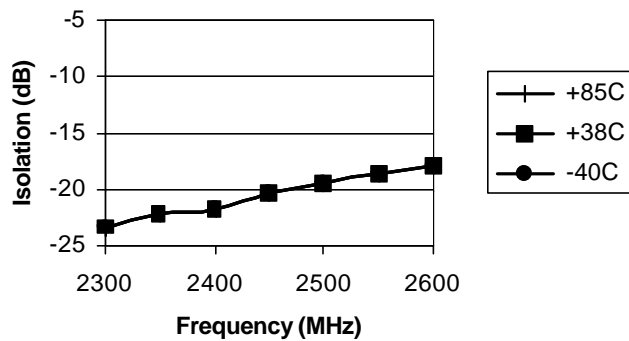

Specifications subject to change without notice.

■ North America: Tel. (800) 366-2266
 ■ Asia/Pacific: Tel.+81-44-844-8296, Fax +81-44-844-8298
 ■ Europe: Tel. +44 (1344) 869 595, Fax+44 (1344) 300 020

Transmit Spectrum Mask, High Power Mode
Pin = 0 dBm

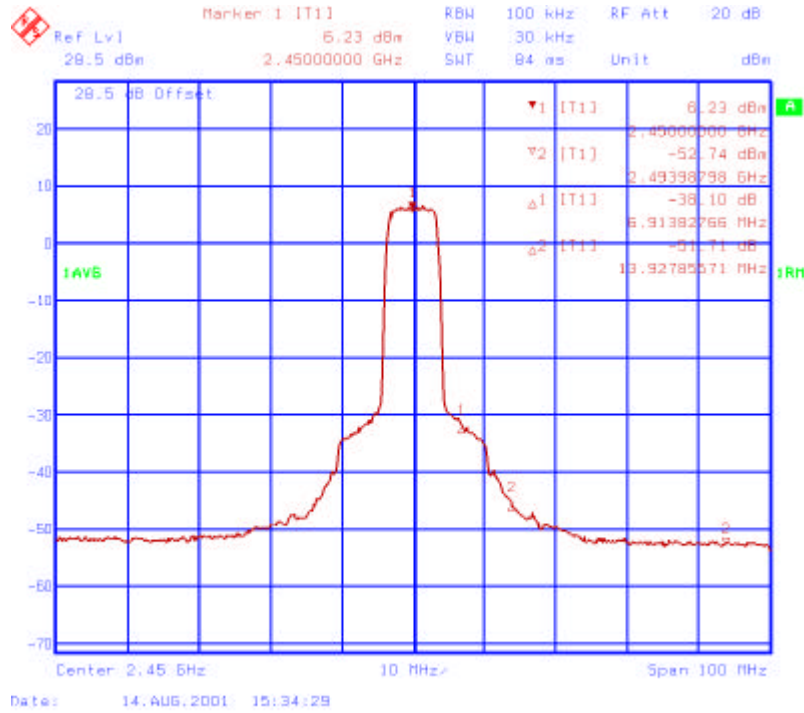

Transmit Spectrum Mask, Low Power Mode
Pin = 0 dBm

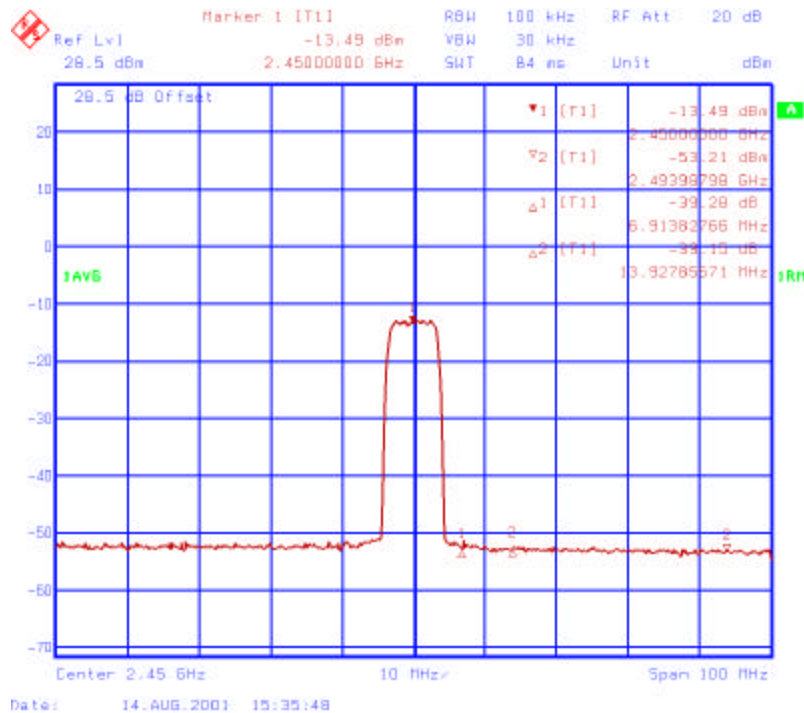

Specifications subject to change without notice.

- North America: Tel. (800) 366-2266
- Asia/Pacific: Tel.+81-44-844-8296, Fax +81-44-844-8298
- Europe: Tel. +44 (1344) 869 595, Fax+44 (1344) 300 020



Application Schematic

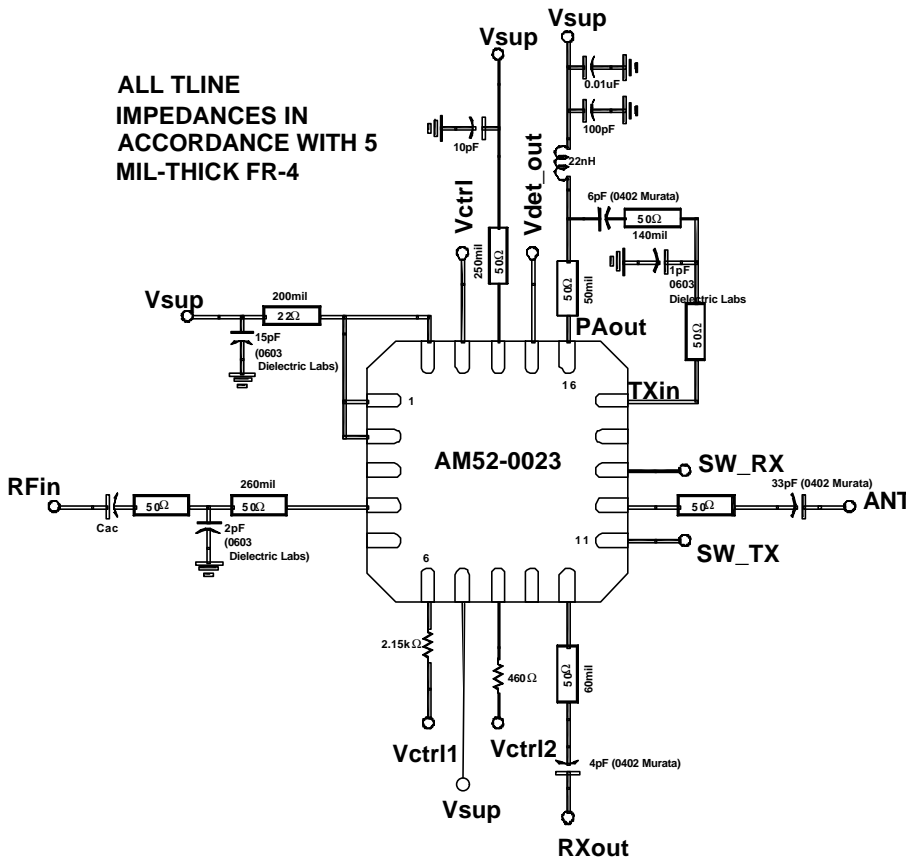

PIN:

1. PA STAGE 1 OUTPUT BIAS (+3V)
2. PA STAGE 1 OUTPUT BIAS (+3V)
3. NO CONNECTION
4. RFIN TO PA
5. NO CONNECTION
6. PA STAGE 1 CONTROL (+3V/0V)
7. PA STAGE 1 CONTROL SUPPLY (+3V)
8. PA STAGE 2 CONTROL (+3V/0V)
9. NO CONNECTION
10. RF OUT FROM ANT
11. T/R SWITCH CONTROL (+3V/0V)
12. ANT
13. T/R SWITCH CONTROL (+3V/0V)
14. NO CONNECTION
15. TX IN FROM PA
16. PA OUT, STAGE 2 OUTPUT BIAS (+3V)
17. DETECTOR OUTPUT
18. DETECTOR SUPPLY (+3V)
19. DETECTOR ON/OFF (+3V/0V)
20. PA STAGE 1 OUTPUT BIAS (+3V)

4 mm, 20 Pin FQFP-N Package

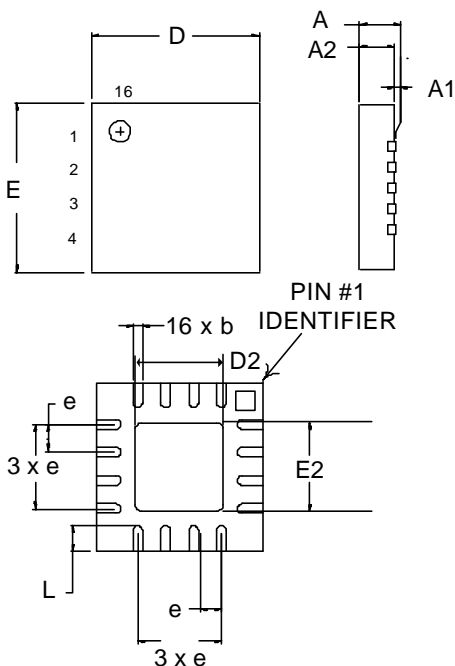

Dimension	Measurement (mm)		
	Min.	Nom.	Max.
A	0.80	0.90	1.00
A1	0	0.02	0.05
A2	0	0.65	1.00
A3		0.20 ref.	
b	0.23	0.28	0.35
D		4.00 basic	
D1		3.75 basic	
D2	0.75	1.70	2.25
e		0.65 basic	
E		4.00 basic	
E1		3.75 basic	
E2	0.75	1.70	2.25
L	0.50 typ.	0.60 typ.	0.75 typ.

Specifications subject to change without notice.

- North America: Tel. (800) 366-2266
- Asia/Pacific: Tel.+81-44-844-8296, Fax +81-44-844-8298
- Europe: Tel. +44 (1344) 869 595, Fax+44 (1344) 300 020